



REGIONE BASILICATA

REGIONE BASILICATA



COMUNE DI COLOBRARO

Provincia di Matera

PROGETTO DEFINITIVO - ESECUTIVO

PROGRAMMA DI AZIONE E COESIONE COMPLEMENTARE AL PON "INFRASTRUTTURE E RETI" 2014-20 - ASSE C "ACCESSIBILITA' TURISTICA"

INTERVENTI PER IL MIGLIORAMENTO DELL'ACCESSIBILITA' TURISTICA DEL SITO ATTRATTORE DI COLOBRARO "PAESE DELLA MAGIA"

ELABORATO N°:

19

DENOMINAZIONE:

**PLANIMETRIE - SEZIONI - PARTICOLARI COSTRUTTIVI -
CARTA LITOLOGICA - CARTA GEOMORFOLOGICA**

SCALA:

1:500-1:100-1:20-1:20

IL COMMITENTE:

COMUNE DI COLOBRARO (MT)

IL PROGETTISTA

Ing. Michele LUPO

IL RESPONSABILE DEL PROCEDIMENTO:

I COLLABORATORI

Ing. Claudio SCANDIFFIO

Geom. Marcello Eliseo MANGO

**STUDIO TECNICO
ING. MICHELE LUPO**

Via Kennedy n° 3 - 75016 Pomarico (MT)

E-mail: michel.lupo@libero.it

P.E.C. michele.lupo@ingpec.eu



CODICE
PROGETTO

...

DATA
PROGETTO

LUGLIO 2020

N. STESURA
ELABORATO

COLLABORAZIONE

COLLABORAZIONE

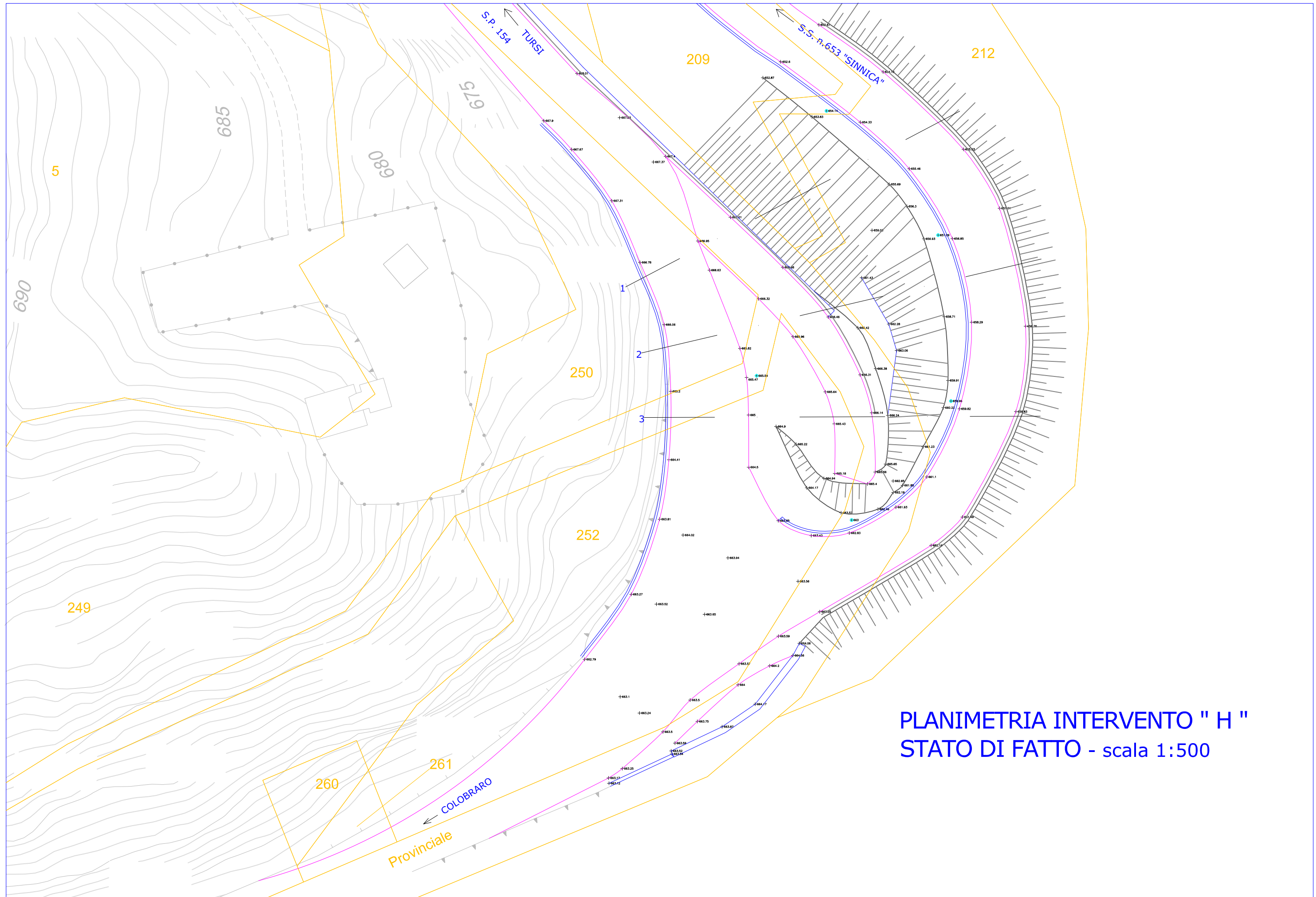

PLANIMETRIA INTERVENTO " H "
STATO DI FATTO - scala 1:500

PROFILO Intervento H

SEZIONE 1 - STATO DI FATTO

PROGRESSIVA 0.00

651.00
500
500

PROGRESSIVE
TERRENO

PARZIALI
TERRENO

QUOTE
TERRENO

PROGRESSIVE
PROGETTO

PARZIALI
PROGETTO

QUOTE
PROGETTO

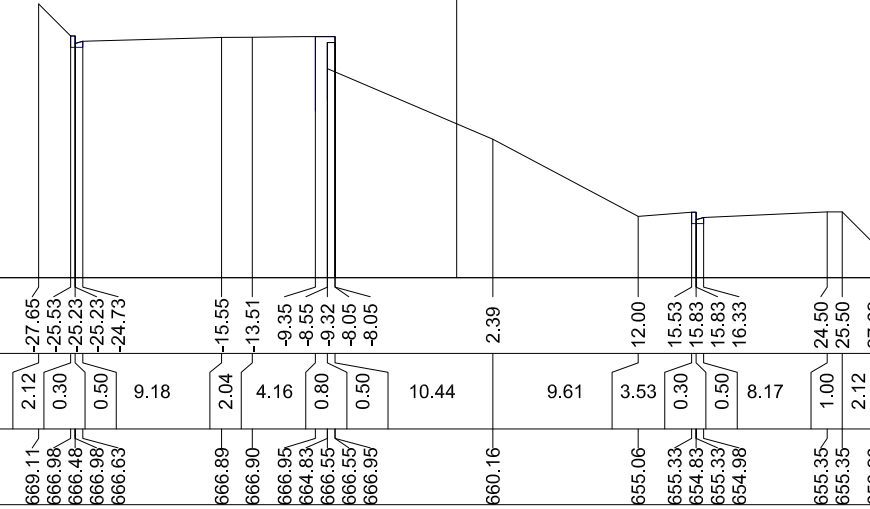

PROFILO Intervento H

SEZIONE 2 - STATO DI FATTO

PROGRESSIVA 0.00

654.00
500
500

PROGRESSIVE
TERRENO

PARZIALI
TERRENO

QUOTE
TERRENO

PROGRESSIVE
PROGETTO





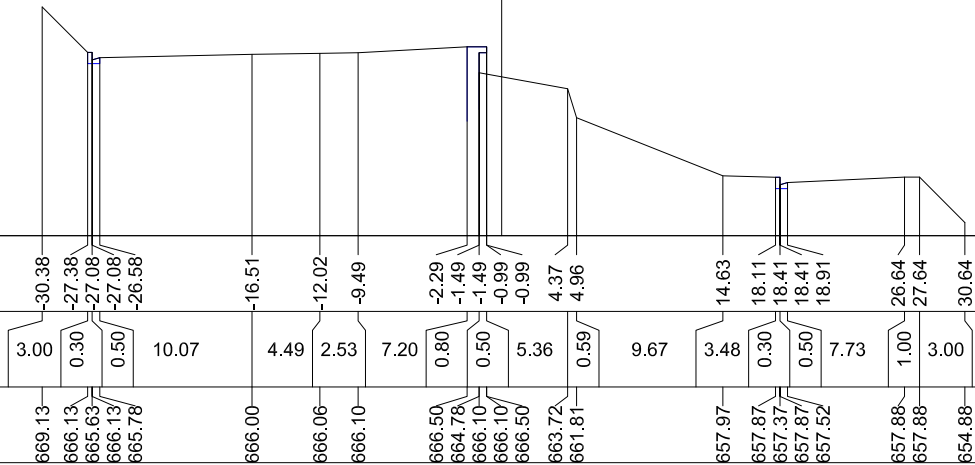

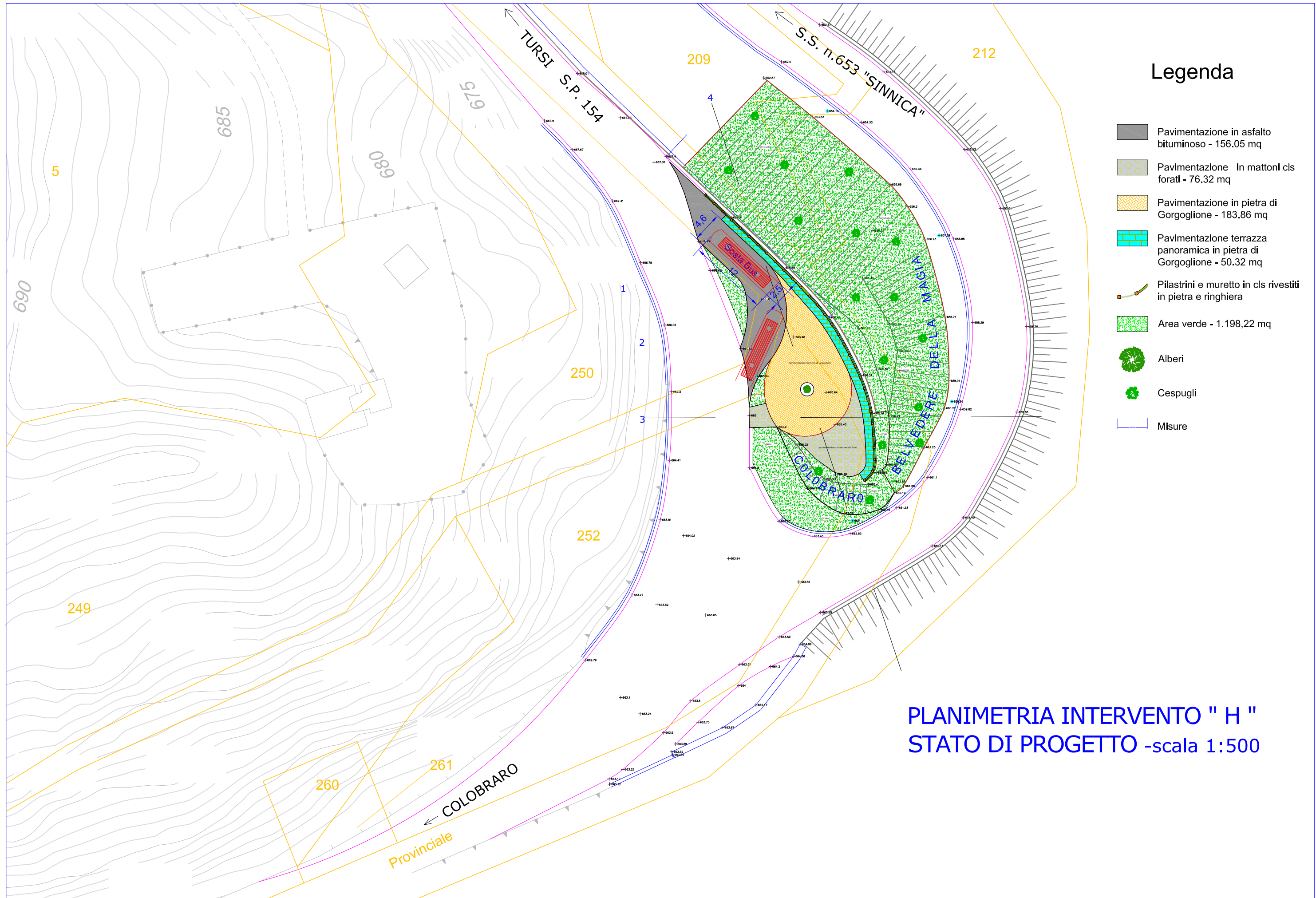

PARZIALI
PROGETTO

QUOTE
PROGETTO





Legenda

-  Pavimentazione in asfalto bituminoso - 156.05 mq
-  Pavimentazione in mattoni cls forati - 76.32 mq
-  Pavimentazione in pietra di Gorgoglione - 183.86 mq
-  Pavimentazione terrazza panoramica in pietra di Gorgoglione - 50.32 mq
-  Pilastrini e muretto in cls rivestiti in pietra e ringhiera
-  Area verde - 1.198,22 mq
-  Alberi
-  Cespugli
-  Misure

PLANIMETRIA INTERVENTO " H "
STATO DI PROGETTO -scala 1:500

PROFILO Intervento H

SEZIONE 3 - PROGETTO

PROGRESSIVA 0.00

656.00
500
500

The diagram shows a cross-section profile with ground and project elevations. The ground profile is shown as a solid line, and the project profile is shown as a dashed line. The profile includes various construction layers and materials, such as concrete, asphalt, and masonry. The elevations are given in meters, and the horizontal distance is in meters.

PROGRESSIVE TERRENO	PARZIALI TERRENO	QUOTE TERRENO	PROGRESSIVE PROGETTO	PARZIALI PROGETTO	QUOTE PROGETTO
-29.36	3.00	668.24	-29.36	3.00	668.24
-26.36	0.30	665.24	-26.36	0.30	665.24
-26.06	0.50	664.74	-26.06	0.50	664.74
-25.56	11.58	664.89	-25.56	11.58	664.89
-13.98	6.11	664.98	-13.98	3.24	664.98
-7.87	3.39	665.10	-10.74	10.74	665.04
-4.48	3.10	665.38	0.00	3.15	665.62
-1.38	5.84	665.47	3.15	1.51	665.87
4.46	2.35	666.11	4.66	2.15	665.97
6.81	4.60	666.23	6.81	4.60	666.47
11.41	3.08	662.54	11.41	3.08	662.54
14.49	4.48	660.43	14.49	4.78	660.43
18.97	0.30	660.27	18.97	0.50	660.27
19.27	0.50	659.77	19.27	5.31	659.90
19.27	5.86	660.27	19.27	3.00	659.90
19.77	3.00	659.92	19.77	29.63	656.90
25.63	1.00	659.90	25.63		
26.63		659.90	26.63		
29.63		656.90	29.63		

PROFILO Intervento H

SEZIONE 4 - PROGETTO

PROGRESSIVA 0.00

659.00
500
500

PROGRESSIVE TERRENO			-25.60	-24.30		-11.82		1.98		17.53	24.81	30.21	30.51	30.51	31.01		41.56	42.56	45.56		
PARZIALI TERRENO		1.30	12.48		13.80	15.55	7.28	5.40	0.30	11.05	1.00	3.00									
QUOTE TERRENO		667.22	667.22		666.70		665.79		664.64	664.09	663.76	663.26	663.76	663.41		663.38	663.38	660.38			
PROGRESSIVE PROGETTO		-25.60	-24.30		-11.78		-1.44		7.74	9.54	12.49	15.52	21.70	24.81	30.21	30.51	30.51	31.01	41.56	42.56	45.56
PARZIALI PROGETTO		1.30	9.97	2.55	10.34		9.18		1.80	2.95	3.03	6.18	3.11	5.40	0.30	11.05	1.00	3.00			
QUOTE PROGETTO		667.22	667.22	667.05	666.95	667.05	666.23	666.33	665.69	665.55	665.35	665.43	664.83	664.09	663.76	663.26	663.76	663.41	663.38	663.38	660.38

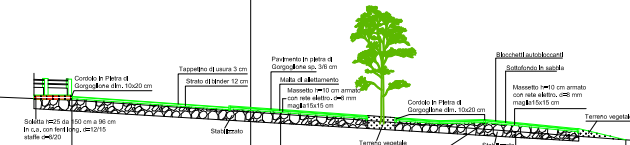

STRALCIO PLANIMETRICO - Scala 1:100

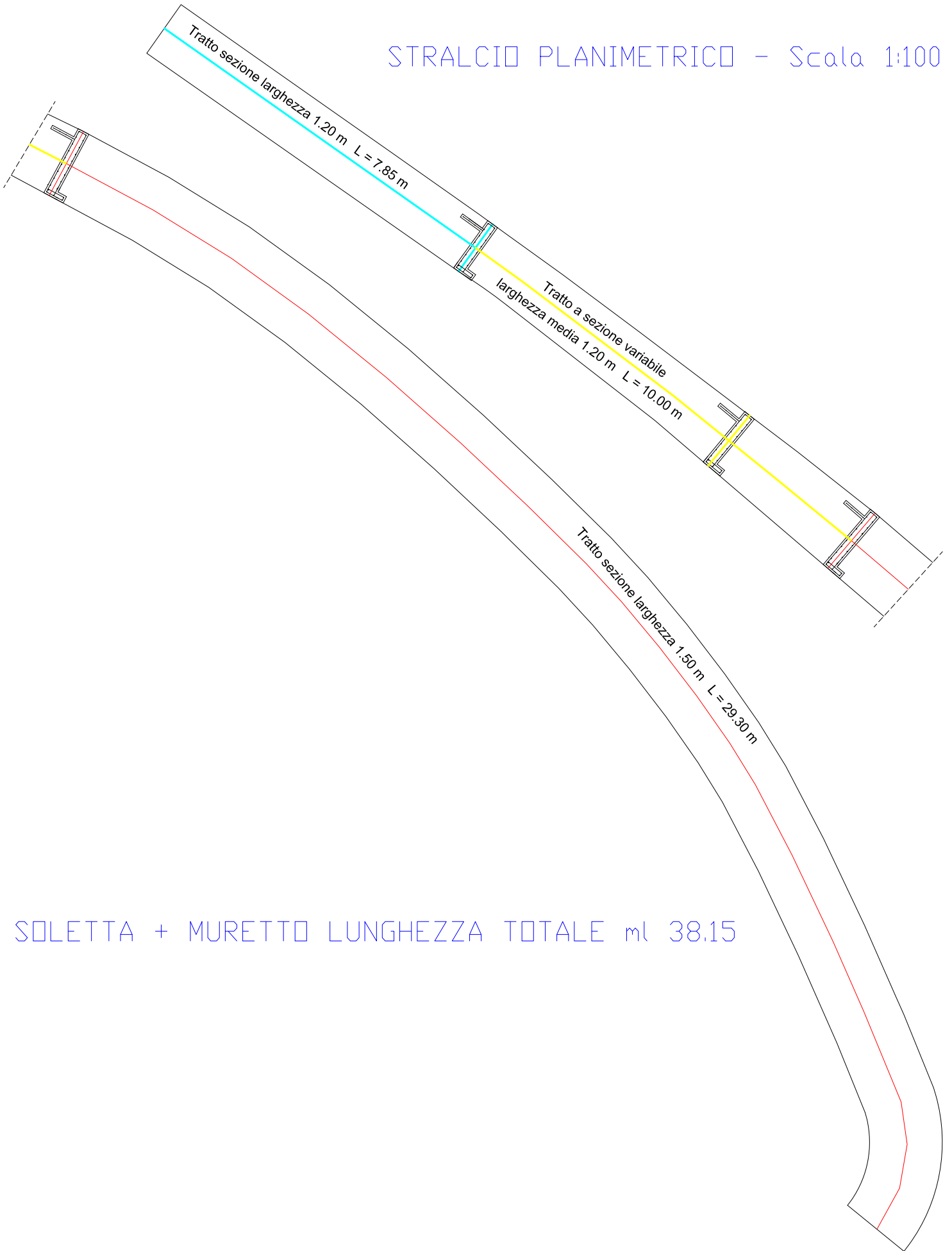

SOLETTA + MURETTO LUNGHEZZA TOTALE ml 38.15

CARPENTERIA E ARMATURA MURETTO + SOLETTA - scala 1:20

STRALCIO PLANIMETRICO - SEZIONE TIPO

Stralcio planimetrico tronco L = 29.30 m

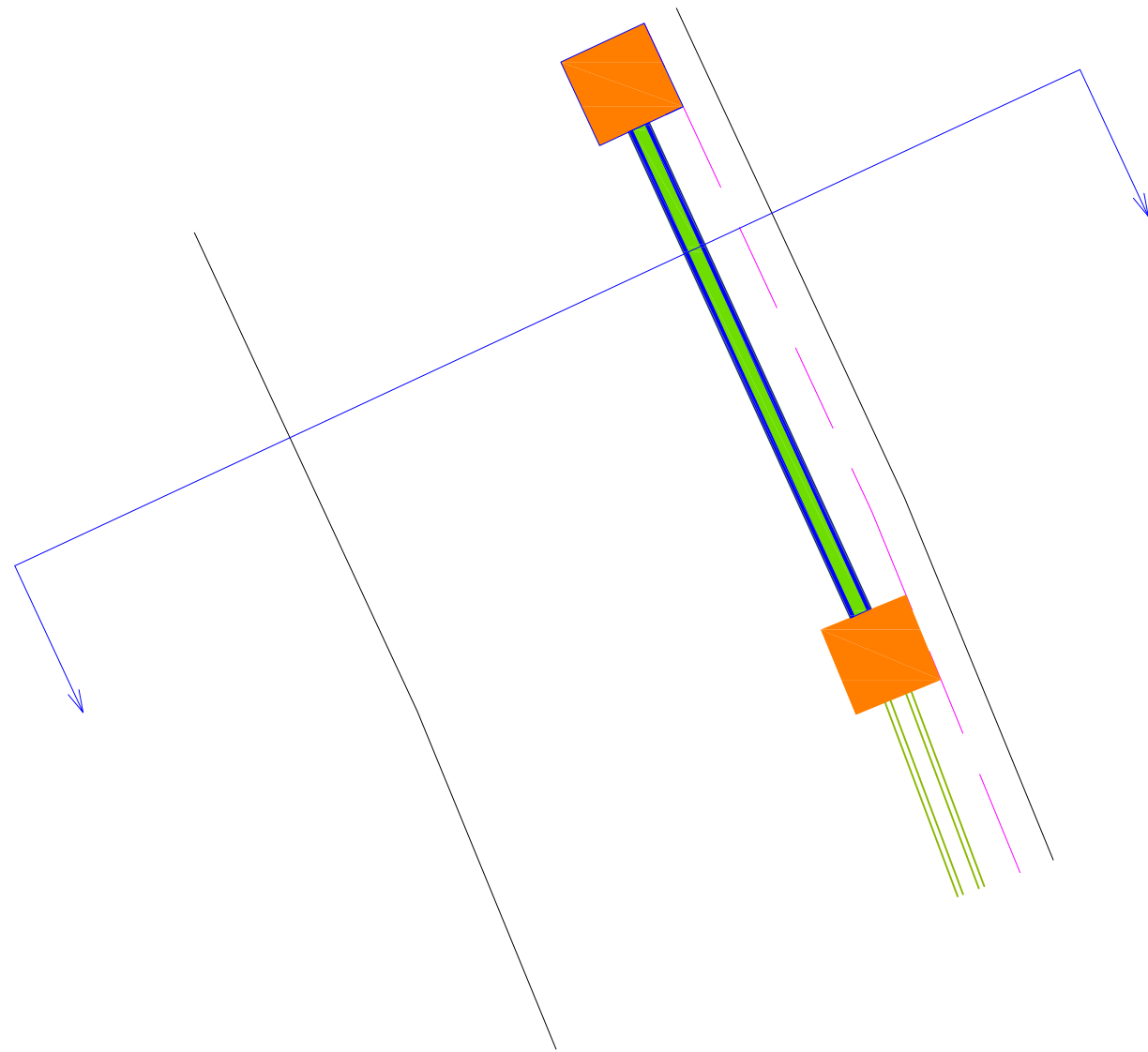

Sezione tipo

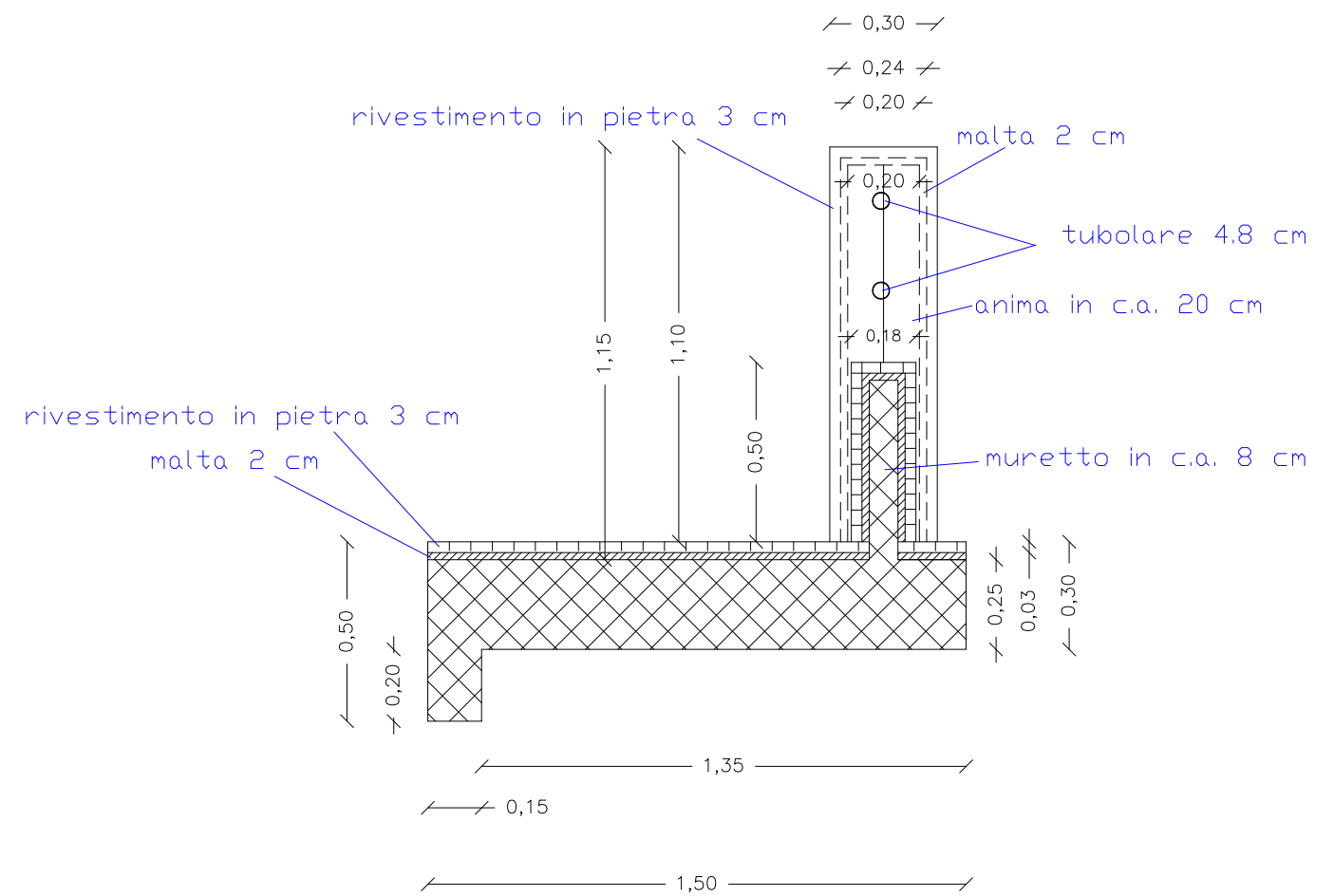

CARPENTERIA E ARMATURA MURETTO + SOLETTA - scala 1:20

TRATTO SEZIONE LARGHEZZA 1.20 m L = 7.85 m

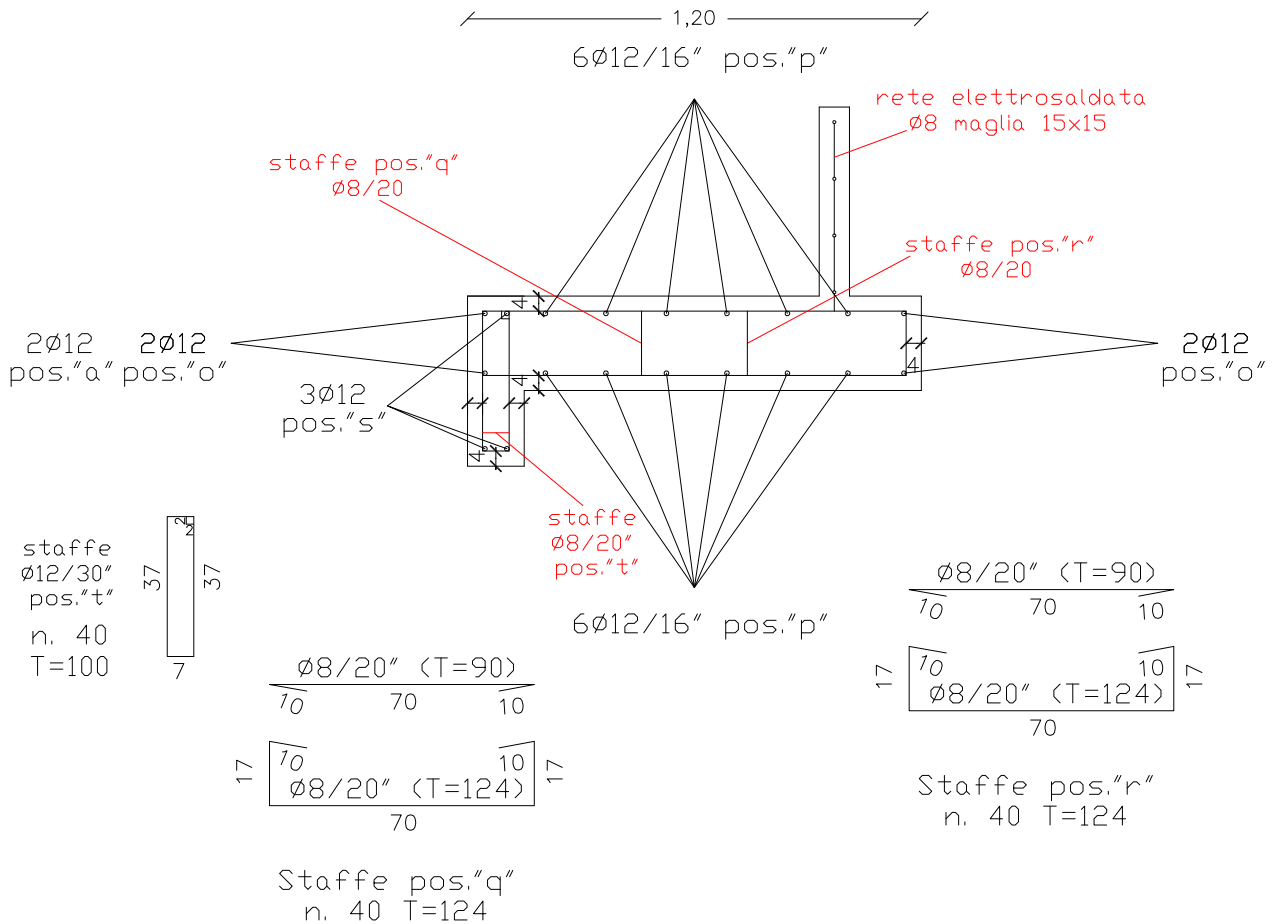
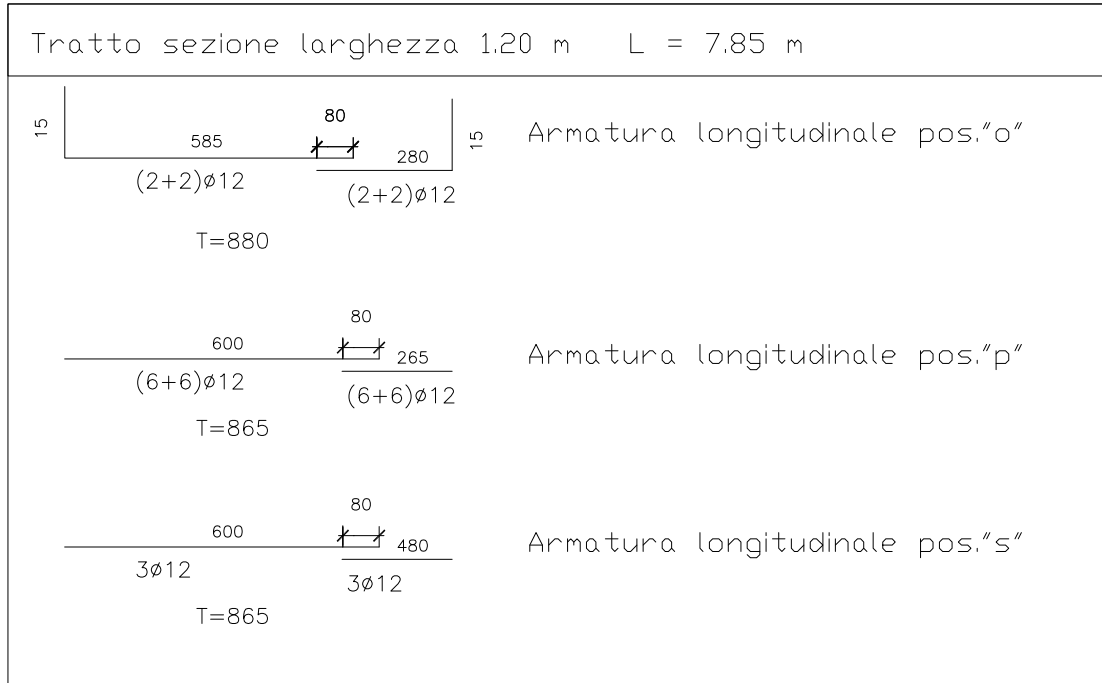

CARPENTERIA E ARMATURA MURETTO + SOLETTA - scala 1:20

TRATTO SEZIONE LARGHEZZA 1.35 m L = 10.00 m

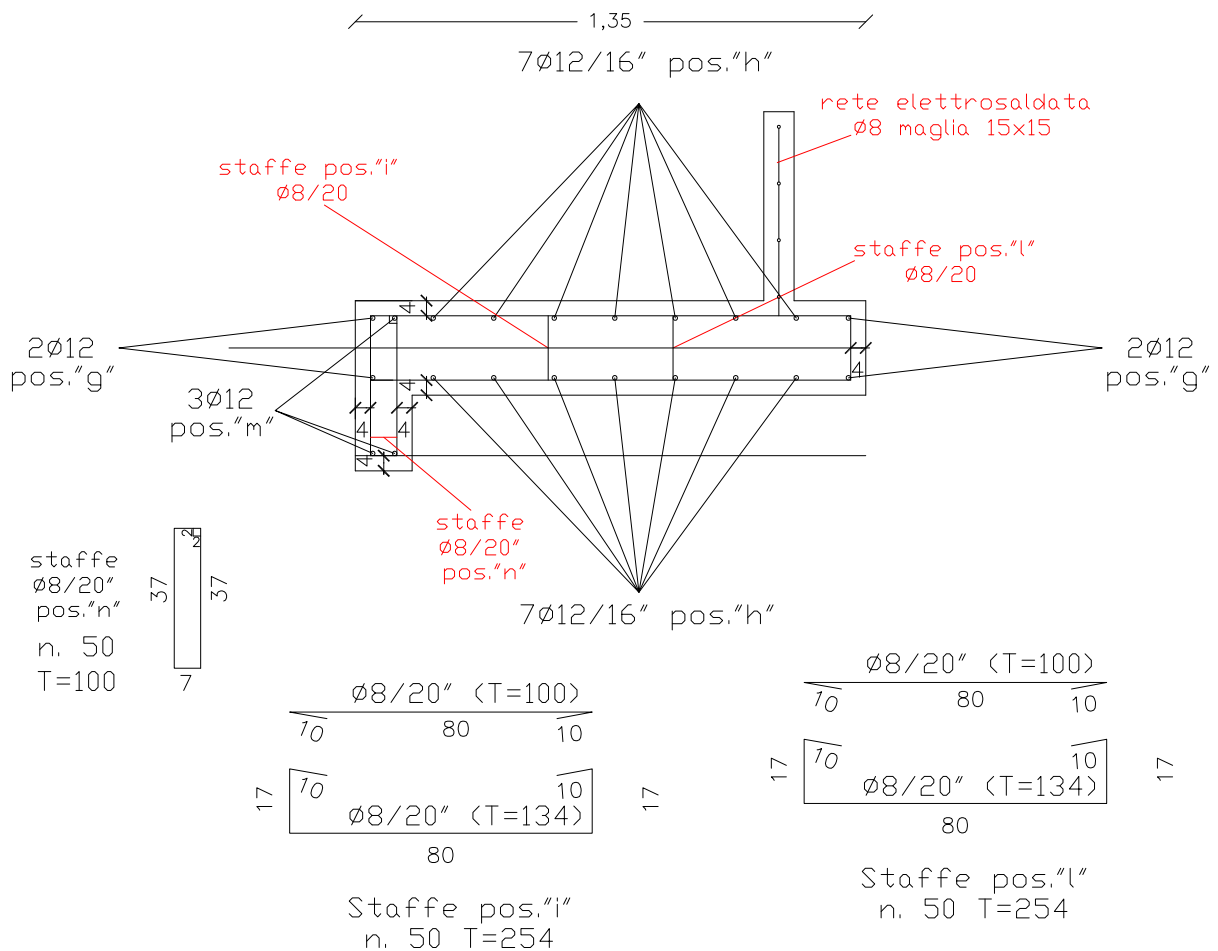
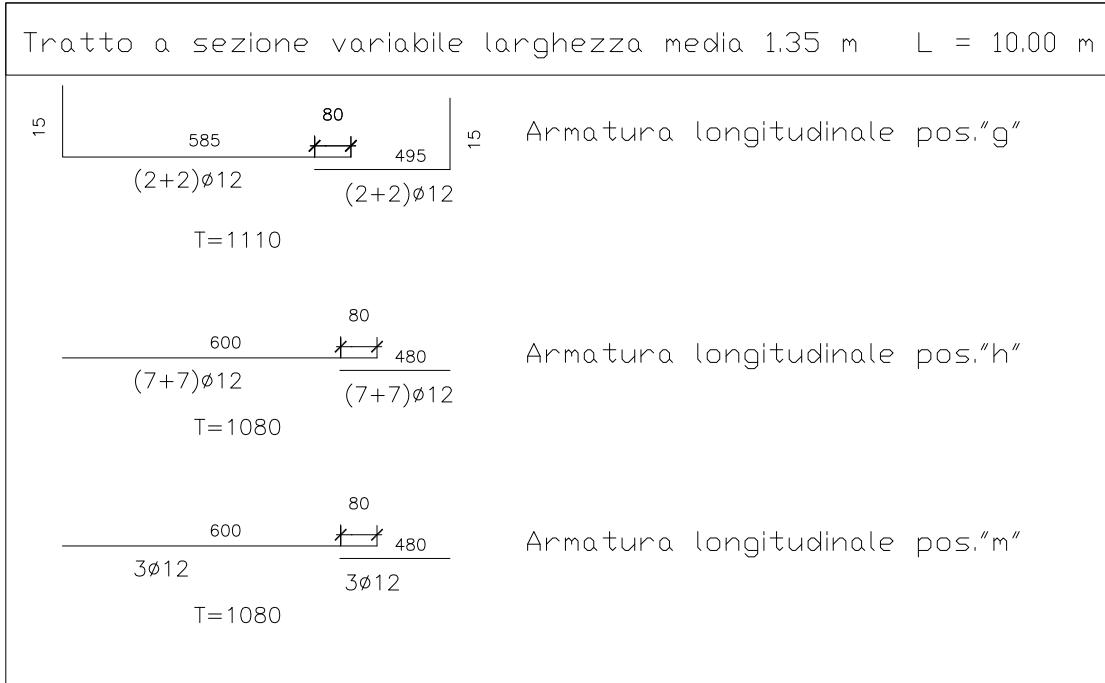

CARPENTERIA E ARMATURA MURETTO + SOLETTA - scala 1:20

TRATTO SEZIONE LARGHEZZA 1.50 m L = 29.30 m

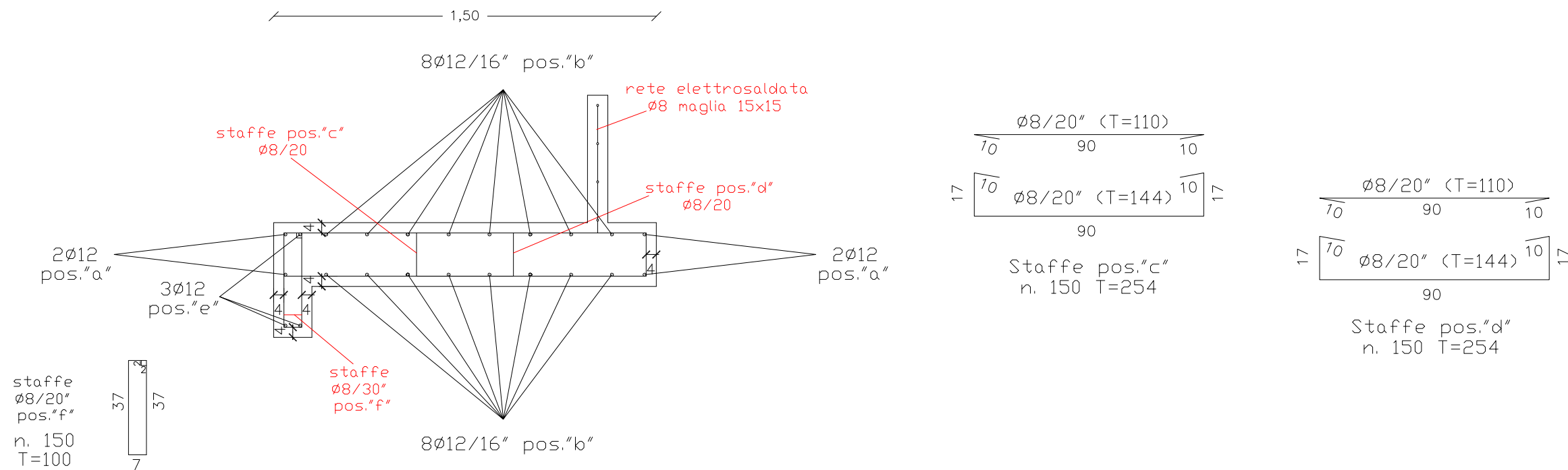
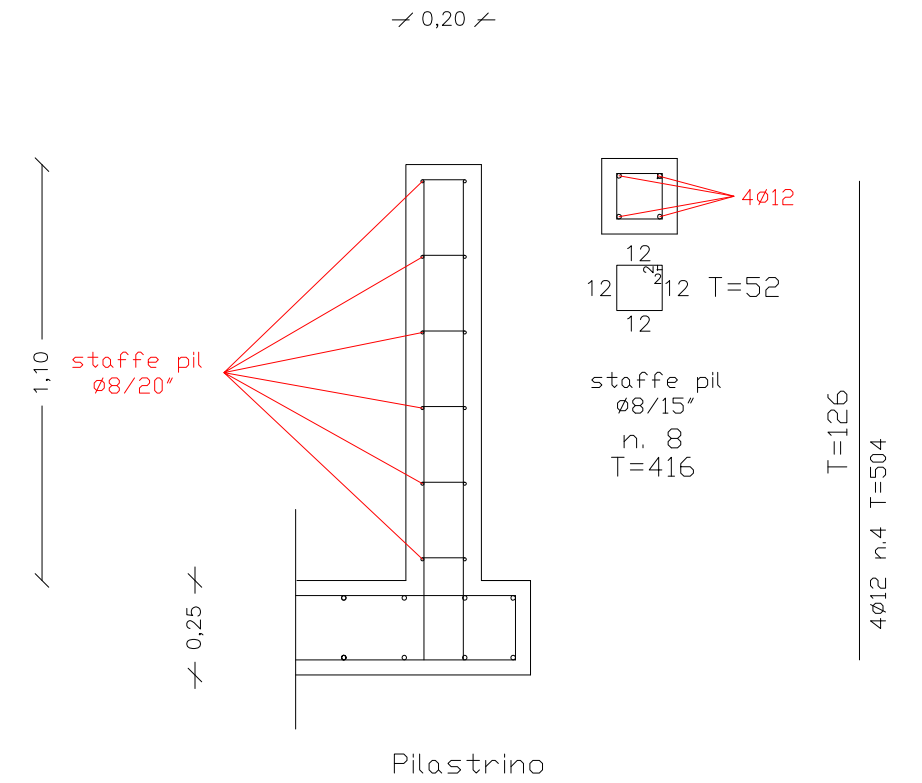
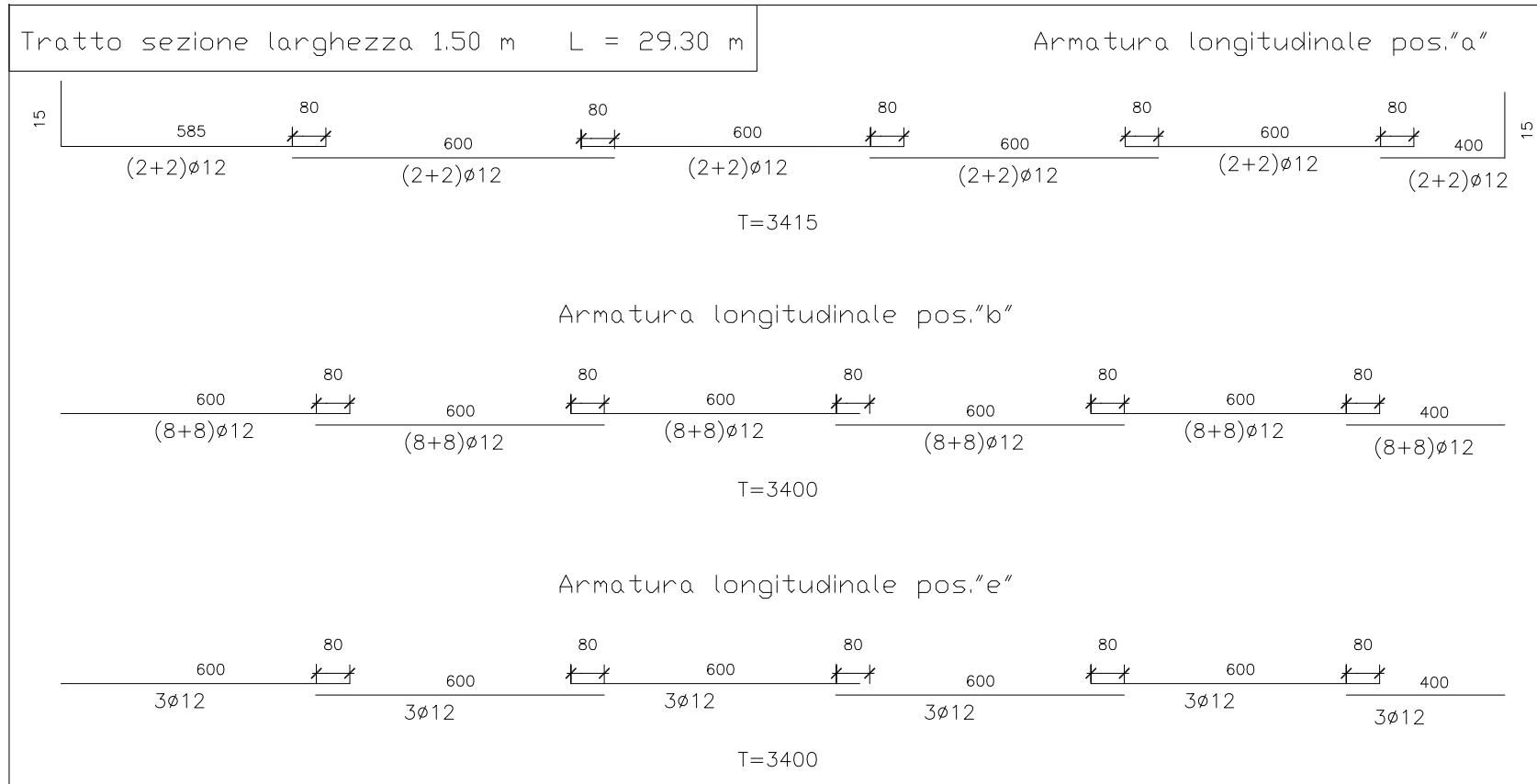

CARTA GEOMORFOLOGICA



Marne e argilliti con erosione diffusa.

